

# AZTH 70<sup>ISH</sup>



2020/2021

# PERSEVERANCE

Schedule Change For November 13, 2021: The 3:10 To Yuma Will Depart 2 Hours And 9 Minutes Early.

*Me, myself, and i*

Scissors | Bowling ball | 6 pole | TP | Sanitizer | Mask | Donkey

Megxit & Oprah??

# The Happiest Place on... Earth??

Aspire to be the Top in the Southwest

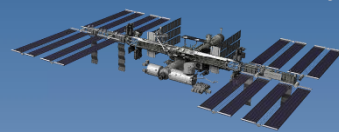

*So you think you can dance?*

Screech!!

#6f4e37



ASCII



Red rover, red rover, send five of them over

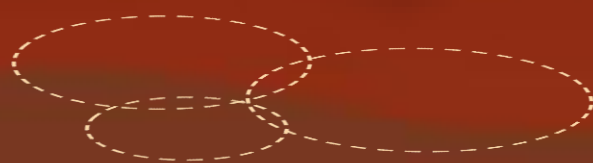

Sometimes animals can see what humans cannot



Who is Alex Trebek?

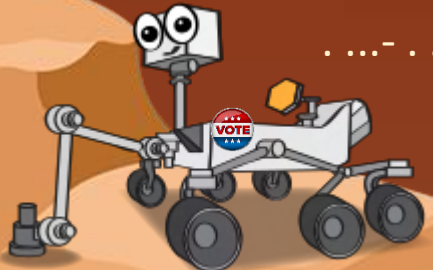
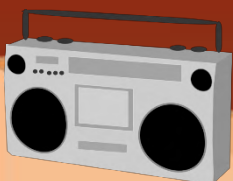

+

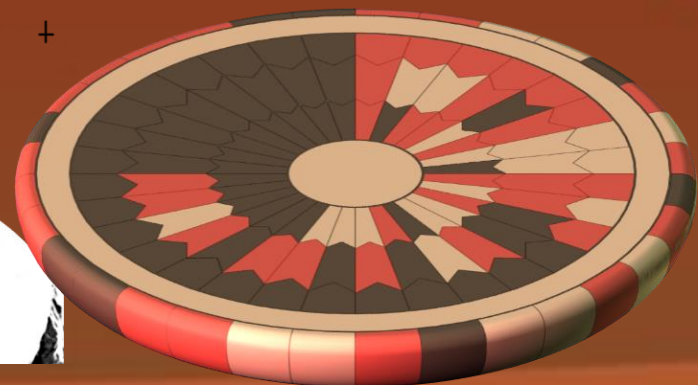

8 24

[Laser Pointer](#)

-Image minted as an NFT



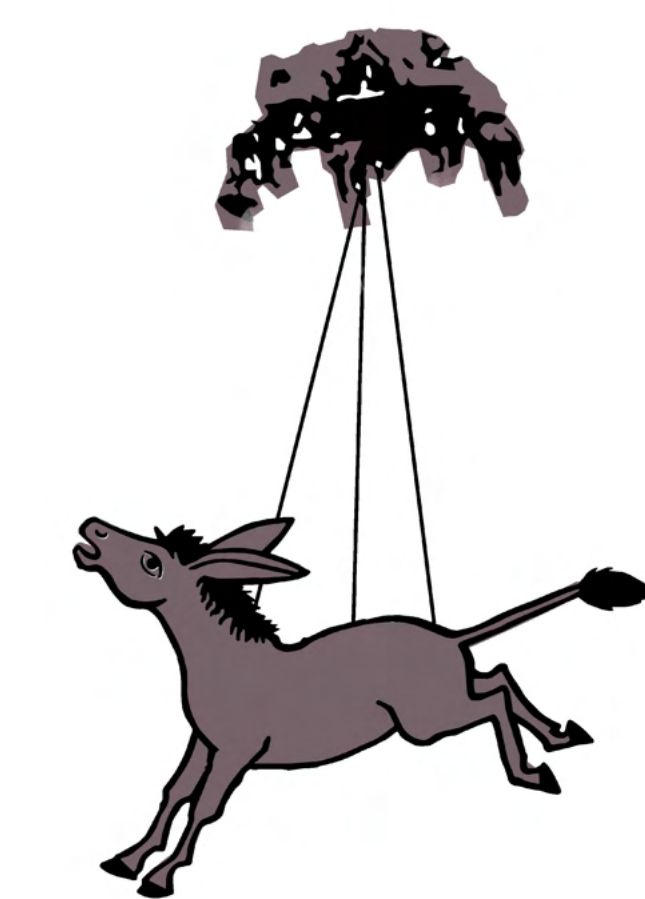

Saint Trotter, The Patron Saint Of Weary, Would-be Wizards... Hear us pray, Oh, Saint Day, Sagacious Saint, Keep us from the sites which ain't. Lead us to the sites which are. But, mostly, Help us find our car!

- NOTES
1. CLUE LOCATIONS MEASURED FROM CENTER LINES OF ROADS.
  2. COMMITTEE RECOMMENDS TRAVEL ONLY ON ROADS SHOWN AND AT LAWFUL SPEEDS!
  3. AT ALL TIMES: SAFETY FIRST. BE CAREFUL!
  4. EXCESS FORCE IS NEVER REQUIRED TO SOLVE THE WORKING CLUES. PLEASE BE GENTLE WITH THEM.
  5. CELL PHONES CAN BE USED FOR GPS.

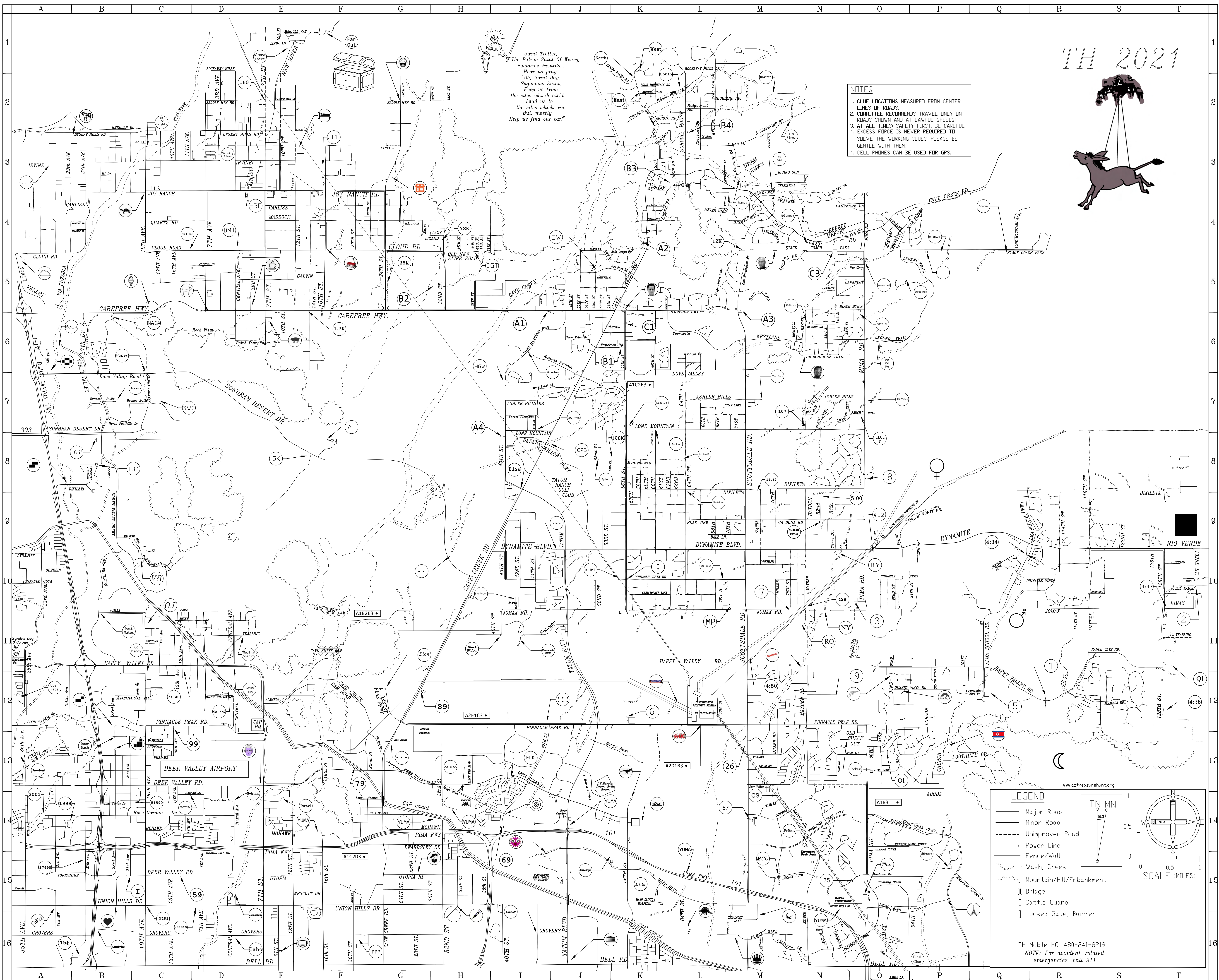

www.aztreasurehunt.org

**LEGEND**

- Major Road
- Minor Road
- Unimproved Road
- Power Line
- Fence/Wall
- Wash, Creek
- Mountain/Hill/Embayment
- Bridge
- Cattle Guard
- Locked Gate, Barrier

TN MN

SCALE (MILES)

TH Mobile HQ: 480-241-8219  
NOTE: For accident-related emergencies, call 911



# **70ish Annual Arizona Treasure Hunt**

TH2021 Hunters:

Putting on this year's Hunt was a triumph of human perseverance -- just like our little buddy looking down from Mars.

2020 was the first year without a Hunt since Harry Truman was president. We regret that. Two years ago, though, we had no idea what challenges we were about to face. While we all love Hunting, we weren't willing to risk the safety of our Hunters and Committee by attempting a Hunt with so much uncertainty.

But 2021 is turning out to be a special year. This year you maxed out our registration limit in record time, so we know you're passionate about Hunting. And the Committee shares your enthusiasm! This team has persevered for the love of the Hunt, and they've used the extra time to make the Hunt better than ever. They deserve our sincere gratitude.

The Hunt has a proud tradition extending back 71 years. Could those first Hunters (Motorola engineers trekking through the remote deserts of Camelback and 40th Street solving differential equations in the dark) have dreamt that we'd still be going today? We'd like to think they're looking down with pride at what the Hunt has become.

The Hunt perseveres because of you, the Hunters. We thank you for your passion, and we can't wait to welcome our newest Committee members!

Brett Carlson and Dan Pote (TH2021 Co-Chairs)

## **AZTH 70**



## **PERSEVERANCE**

# **Brown Bag Contents 2021**

Map  
Emergency envelopes  
Check-in instructions  
Sticker / Score sheet  
HWOW on three hole punched paper  
Escape room 8% discount business card  
Popsicle stick  
Pink balloon  
Zip tie  
Baseball bead  
C2 Tactical Coupon  
Straw  
Schilling Hard Cider Sticker  
Birthday candle  
Safety pin  
Q-tip  
Cap eraser  
Beer-pong ball  
Blue "Official Map Marker"  
List of famous people deaths  
Thumbtack  
Ink pen  
Decoder, musically decorated  
Elder Futhark Runes  
Hall & Oats album tracks  
Points needed for song winners  
2021 Baseball Hall of Fame ballot  
List of conspiracy theories  
Hershey's Kiss in velour baggie  
Amusement Park ticket  
Rules of Population  
Planetary symbols  
Quotes of compliments  
Examples of "Vanity Plates"  
Script from Commander  
Olympic facts and stats  
List of yard games

**This is Clue A. Solving this clue will lead you to Clue B.**

*This is a Visual Clue where Hunters encounter a display with colorful rings, numbers, and city names. The visual states 'IT ALL ADDS UP'*

Athens 28

Tokyo 18

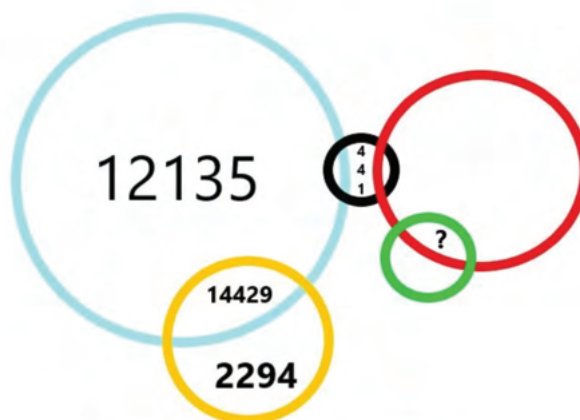

Los Angeles 23

**IT ALL ADDS UP**

Tokyo 32

**If you are unable to solve this clue, or to find Clue B, open emergency envelope 6, which will direct you to Clue B.**

**This is emergency solution 6, which will lead you to Clue B.**

The keen-eyed hunter will recognize the colored rings as those belonging to the official Olympics symbol. Each ring represents a continent. If you review the Olympics Facts and Stats sheet provided in the brown bag, you will notice that the number of overall medals by continent is given. The red ring represents the Americas and the green ring Oceania.

If you solve the sum of those two numbers, Americas (4250) and Oceania (717), you get **4967**.

**4967** solves the question mark. But the clue also says to **add it all up**:  $4 + 9 + 6 + 7 = 26$

The clue also shows four cities that hosted the Summer Olympics and a corresponding number of the order in which that city hosted the Summer Olympics. The HWOW provided a link to a list of all host cities to the summer Olympic Games.

The 26th official host of the Olympic Games is **Atlanta**

**If you are unable to locate Clue B, open emergency envelope 17, which will direct you to Clue C.**

**This is Clue B. Solving this clue will lead you to Clue C.**

*This is a Visual Clue where Hunters will find at the clue-site a pedestal with the platform shaped like a baseball "home plate." On the "Home Plate" is a solved Aristotle Puzzle. On the bottom of the puzzle will be a small trademark "Green Monster Games."*



**If you are unable to solve this clue, or to find Clue C, open emergency envelope 17, which will direct you to Clue C.**

**This is emergency solution 17, which will lead you to Clue C.**

Upon studying the board hunters will see numbers between 1 and 19 printed on each tile. And looking further, they should notice that all rows, columns, and diagonals all add up to 38. But what does 38 suggest? And why is the platform shaped like home plate?

On the HWOW there was a link to the 2001 Arizona Diamondback's World Series roster with all the players and their uniform numbers. In the brown bag there was a sample ballot for the 2021 Baseball Hall of Fame. Where is the overlap? Why, Curt Shilling, the founder of Green Monster Games, wore number 38 and is on the ballot for the 10th and final time!

All signs point to Mr. Shilling, so pitch straight for circle:

CS

**If you are unable to locate Clue C, open emergency envelope 10, which will direct you to Clue D.**

**This is Clue C. Solving this clue will lead you to Clue D.**

*This is a working visual clue where the hunters approach a set of wooden pins on a platform lined with turf.*



**If you are unable to solve this clue, or to find Clue D, open emergency envelope 10, which will direct you to Clue D.**

**This is emergency solution 10, which will lead you to Clue D.**

Hunters will approach a strange, yet familiar game at the clue site. The astute hunter will recognize an opportunity to use their bowling ball! But after playing a couple rounds, it's obvious this is not a normal bowling alley or normal bowling pins...and what's that written on the bottom of those funny pins? TASTE? Hopefully the list of yard games in the brown bag will help you realize what game you're currently playing: not bowling, but skittles! What would one taste in a game of Yard Skittles? The rainbow of course.

Proceed to:



**If you are unable to locate Clue D, open emergency envelope 18, which will direct you to Clue E.**



**This is Clue D. Solving this clue will lead you to Clue E.**

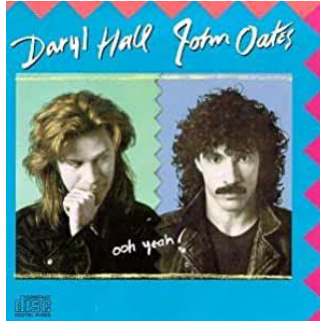
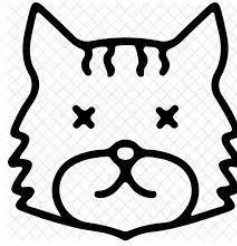

**If you are unable to solve this clue, or to find Clue E, open emergency envelope 18, which will direct you to Clue E.**

**This is emergency solution 18, which will lead you to Clue E.**

You find four seemingly unrelated pictures. Ain't that a woman, a yellow airplane, a dead cat, and a Mars rover? And Daryl Hall seems to be asking John Oates, "How long was this track?"

But that's not just any woman; that's the abolitionist Sojourner Truth. The yellow plane is the mascot of Spirit Airlines. What do you suppose killed the cat, if not curiosity? And the studious hunter will recognize the Mars rover as the theme of this year's hunt: Perseverance. Sojourner, Spirit, Curiosity, and Perseverance. These are four of the five rovers built by NASA Jet Propulsion Laboratory and sent to Mars. The only one missing is Opportunity. The picture of Hall & Oates is the cover of their album Ooh Yeah!, on which the track titled "Missed Opportunity" is how long? Four minutes and 47 seconds.

Let's not 🎵 *keep on ... missing each other* 🎵 Go to **4:47**

**If you are unable to locate Clue E, open emergency envelope 26, which will direct you to Clue F.**



**This is Clue E. Solving this clue will lead you to Clue F.**

$$[(\hat{\odot} * \oplus) - \text{♀}] / \text{♀} - [1/2 (\hat{\odot} + i^2)] + [(\Psi - \text{♁})^3 / \text{♀}] + (2 + \text{♀}) - (\hat{\odot} + \hat{\odot}) =$$

**If you are unable to solve this clue, or to find Clue F, open emergency envelope 26, which will direct you to Clue F.**

**This is emergency solution 26, which will lead you to Clue F.**

The Hunter finds a mathematical operation of planetary symbols, but how to calculate? By using their smarts, of course! The Hunter must use the number that corresponds to each planet in the Solar System (along with the imaginary number  $i$ ) to arrive at the final answer = 4. But where is the 4 on the map? The symbol for the planet Mars is interestingly a circle with an arrow. The Hunter finds this Mars symbol on the map which disguises itself within the other circles around it.

$$[(7*3) - 1]/2 - [1/2 (7+i^2)] + [(8-6)^3/2] + (5 + 2) - (7+7) = 4$$

*Note: the imaginary number squared ( $i^2$ ) = -1*

Head over to: 

**If you are unable to locate Clue F, open emergency envelope 1, which will direct you to Clue G.**



**This is Clue F. Solving this clue will lead you to Clue G.**

P is to LS

M is to OK

D is to RT

H is to \_\_\_

**If you are unable to solve this clue, or to find Clue G, open emergency envelope 1, which will direct you to Clue G.**

**This is emergency solution 1, which will lead you to Clue G.**

Looking at the letters, an astute hunter will realize that the letters actually spell complete words:

PistoLS

MistoOK

DistoRT

Thus, H is to \_\_\_ is actually, Histo\_\_\_.

Add an RY to complete the word HistoRY, and head on over to:

**RY**

**If you are unable to locate Clue G, open emergency envelope 19, which will direct you to Clue H.**



**This is Clue G. Solving this clue will lead you to Clue H.**

*This is a working visual clue. The hunters approach a kissing booth manned by a wizard, but all COVID precautions are obvious and they cannot approach closer than 6' for their kiss.*



**If you are unable to solve this clue, or to find Clue H, open emergency envelope 19, which will direct you to Clue H.**

**This is emergency solution 19, which will lead you to Clue H.**

How to kiss with Covid precautions in place? What could you possibly use to Kiss this wizard while also remaining 6' away? Hunters will find the silver Hershey's Kiss in a small bag very handy when using the 6' pole they didn't forget because of the kind reminder on the HWOW. Using those tools, the hunters can give a kiss to the wizard in the kissing booth. The wizard will return the gesture by replacing their candy with a golden hershey's kiss. A silver kiss for a golden kiss!

But what to do with a GOLDEN KISS? Those who have done their research will know that this is a common name for the famous painting listed on the HWOW by the one and only, Gustav Klimt.

Proceed to:

**KLIMT**

**If you are unable to locate Clue H, open emergency envelope 16, which will direct you to Clue I.**

**This is Clue H. Solving this VISUAL clue will lead you to Clue I.**

*This is a visual clue. The hunters approach a clue site that appears to be empty, but is directly in front of large powerlines that have numbers spray painted on them.*

**If you are unable to solve this VISUAL clue, or to find Clue I, open emergency envelope 16, which will direct you to Clue I.**

**This is emergency solution 16, which will lead you to Clue I.**

Hunters arrive at the clue site only to find the sticker dispenser and binder next to a transmission tower. And it says it's a visual clue. What can they see? The only visual around is the tower itself. An astute Hunter might think of the instructions on the HWOW: "Sometimes what you want is right in front of you. All you have to do is open your eyes and see it."

$$214/2 = 107$$

So head over to: **107**



**If you are unable to locate Clue I, open emergency envelope 22, which will direct you to Clue J.**



**This is Clue I. Solving this clue will lead you to Clue J.**

Answer: The highest possible winnings of the game below

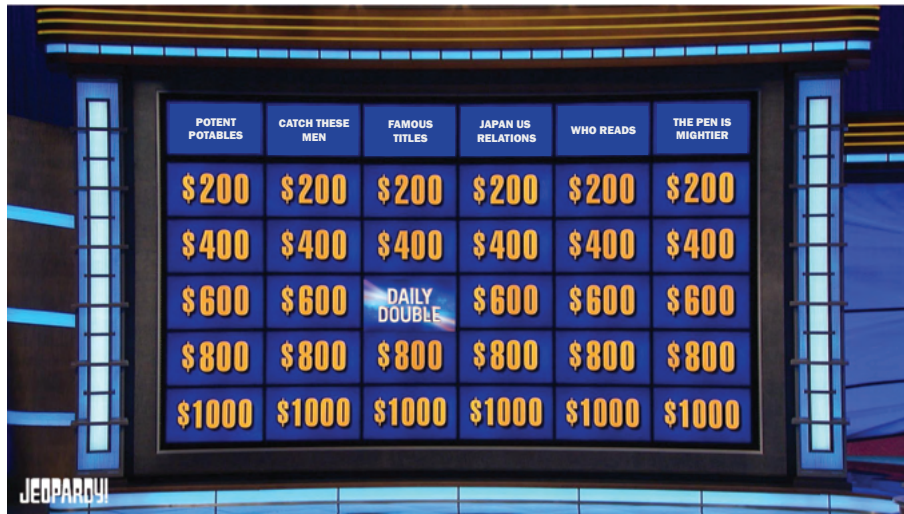

**If you are unable to solve this clue, or to find Clue J, open emergency envelope 22, which will direct you to Clue J.**

**This is emergency solution 22, which will lead you to Clue J.**

Once you get past the nostalgia and sadness thinking about beloved host Alex Trebek, put your contestant hat on. Alex has given you the answer of “the highest possible winnings of the game below.” Well, what is unique about this game of Jeopardy? The very first question is a daily double.

As a prepared hunter, you read the Jeopardy rules on the HWOW-linked Jeopardy page and know the maximum possible daily double wager is the larger of the highest remaining clue value on the board or your current score, the maximum this first question of the game can be worth is \$1,000. So the Jeopardy round maximum score is 5 categories of \$3,000, plus one category of \$2,400 plus \$1000, or \$18,400. If the daily doubles are each on \$400 squares and are chosen last in Double Jeopardy, you can go into Final Jeopardy with \$214,400, put it all on the line, and walk away with \$428,800.

Hope you didn't forget about the Daily Double being the first square chosen and end up at the \$566,400 site along with Mike Richards your Jackass friends.

Go to: (\$428.8K)

**If you are unable to locate Clue J, open emergency envelope 7, which will direct you to Clue K.**

**This is Clue J. Solving this clue will lead you to Clue K.**

*This is a visual clue with a post approximately 6 ft tall. A free-swinging pendulum hangs from a hook at the top. The bottom of the pendulum has a strip of LEDs. Small 'blinds' on each side of the LED strip prevent other teams from seeing the LEDs. The LEDs are constantly flashing, sometimes in green, sometimes in red, and periodically a short, white flash.*

Green  °  ,  ”  
Red  °  ,  ”

**If you are unable to solve this clue, or to find Clue K, open emergency envelope 7, which will direct you to Clue K.**

**This is emergency solution 7, which will lead you to Clue K.**

Swinging the pendulum reveals that the flashing lights display words, three in green and three in red. Each swing of the pendulum displays a single word. Six swings reveal words in the following order: LANDING (green), LASAGNE (red), FLAT (green), STARGATE (red), JACKASS (green), FINLAND (red)

Six excerpts from brown bag conspiracy list contain the best-fit matches for the six displayed words:

- 33° The Moon **landing** was faked.
- 111° The UK Government is baking a giant **Lasagne** the size of Wembley Stadium.
- 47' The Earth is **flat**.
- 57' Saddam Hussein had a **stargate**.
- 58" Donkey, in Shrek, is a boy from Disney's "Pinocchio" who was turned into a **jackass**.
- 38" **Finland** doesn't exist.

Using the page provided at the clue site, fit these coordinates in order: 33° 47' 58", -111° 57' 38"  
Enter in Google maps (per the HWOV link) to find the location in map territory with the circle:  
(The face of Q, not an anon, but the character from Star Trek: The Next Generation)



**If you are unable to locate Clue K, open emergency envelope 12, which will direct you to Clue L.**



**This is Clue K. Solving this clue will lead you to Clue L.**

*This is a Visual Clue where the Hunters encounter a grid-like map titled ISS with instructions playing in the background.*

ISS	A	B	C	D
1				✓
2		✓		X
3			X	
4	X			X
5			YOU ARE HERE	
6	✓			✓

**If you are unable to solve this clue, or to find Clue L, open emergency envelope 12, which will direct you to Clue L.**

**This is emergency solution 12, which will lead you to Clue L.**

A well trained ~~hunter~~ Cosmonaut will refer to their training guide on how to navigate the International Space Station. Your Commander, although heroic, is somewhat dull-witted, his commands are rather incomplete. But with a little deciphering using your ISS map, you should be able to figure out that although there are multiple ways to navigate his directions they will all lead to the same final destination.

And once you do, you'll realize that you end up in grid A4, so fly your ship on over to:

A4

ISS	A	B	C	D
1		←	←	✓ ↑
2	←	✓ ↓	→	X
3	↓		X ↑	
4	X ↓		↑	X
5			YOU ARE HERE	
6	✓			✓

**If you are unable to locate Clue L, open emergency envelope 3, which will direct you to Clue M.**

**This is Clue L. Solving this clue will lead you to Clue M.**

*This is a visual clue where the hunters will walk up to a display with a pre-recorded Treasure Hunt Committee meeting running on loop.*

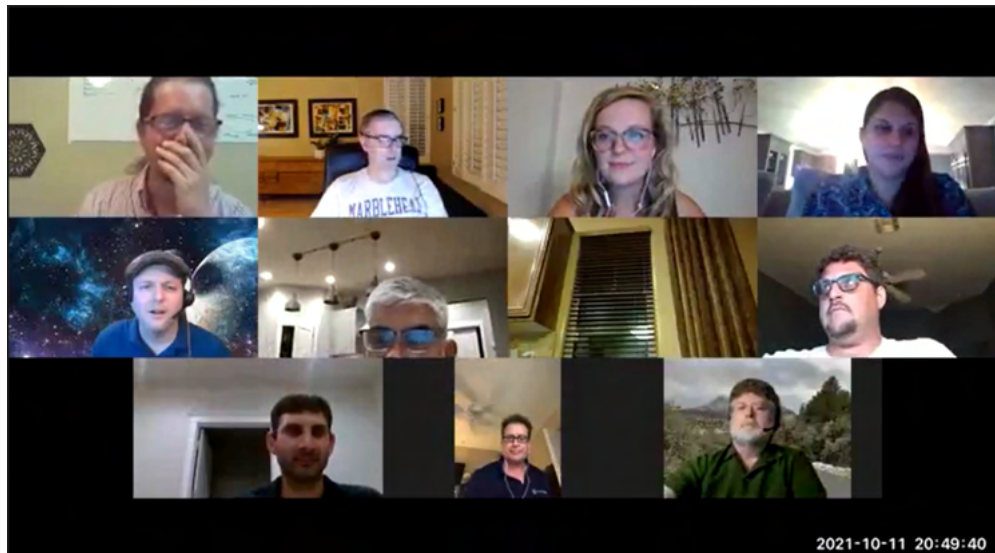

**If you are unable to solve this clue, or to find Clue M, open emergency envelope 3, which will direct you to Clue M.**

**This is emergency solution 3, which will lead you to Clue M.**

Everyone has been on zoom so far this year, so hopefully we all know how to use it by now. Right? Well as the hunters watch this recorded Treasure Hunt Committee meeting unfold, they will witness some of the most stereotypical gaffs that Boomers make on zoom: muting issues, face filter issues, camera malfunctions... The Gen Z or Zoomers on the call reach out to correct them, always directing them to the Three Dot Menu. How many times do you need to be told to go to the three dots?

So go to: 

**If you are unable to locate Clue M, open emergency envelope 25, which will direct you to Clue N.**



**This is Clue M. Solving this clue will lead you to Clue N.**

*This is a Working Visual Clue where Hunters encounter kids' xylophones with the music to 'Twinkle, Twinkle, Little Star' playing from a speaker in that same instrument.*



**If you are unable to solve this clue, or to find Clue N, open emergency envelope 25, which will direct you to Clue N.**

**This is emergency solution 25, which will lead you to Clue N.**

A xylophone and a catchy tune playing under the stars.....a tune everyone surely knows. Hopefully that someone in your van who has a musical ear took the time to learn the xylophone! Now that you've figured out the 14 notes, write them down to help the other budding xylophonists in your van get it right. Wait, that notes template from the Brown Bag has just the right number of spaces! But what do these arrows and numbers above the notes mean?

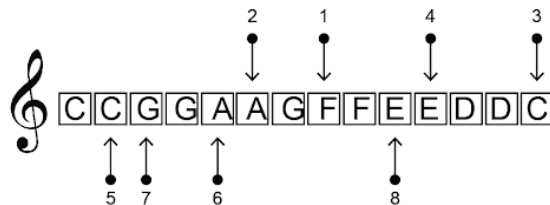

The top row spells FACE and the bottom row CAGE... Which sounds like a great description of what we've all been wearing for the past 18 months!

So pull that mask back over your nose, and head right between Dr. Fauci and his syringe to



**If you are unable to locate Clue N, open emergency envelope 21, which will direct you to Clue O.**

**This is Clue N. Solving this clue will lead you to Clue O.**

# 781-261-0421

**If you are unable to solve this clue, or to find Clue O, open emergency envelope 21, which will direct you to Clue O.**

**This is emergency solution 21, which will lead you to Clue O.**

Sharp hunters are sure to call this listed phone number immediately, but alas only a voicemail box? What next? The recorded message indicated that you should try something different... How about the *difference*?

$$\begin{array}{r} 781 \\ -261 \\ \hline -0421 \\ \hline 99 \end{array}$$

Ninety-nine: The percentage of Wizards who thought you would solve this clue!

So head on over to: **99**

**If you are unable to locate Clue O, open emergency envelope 2, which will direct you to Clue P.**

**This is Clue O. Solving this clue will lead you to Clue P.**

Heroes x (Arcade – Een beetje) – ((La,La,La)<sup>2</sup> + Puppet on a String x (What's Another Year +  $\sqrt{\text{Non ho l'età}}$ ) + Waterloo x Tom Pillibi<sup>2</sup>

---

My Number One

**If you are unable to solve this clue, or to find Clue P, open emergency envelope 2, which will direct you to Clue P.**

**This is emergency solution 2, which will lead you to Clue P.**

The astute hunter who exhaustively researched the HWOW and brown bag contents will recognize these variables as song titles to the winners of various years of Eurovision. Behold the calculation of your wildest imagination. Nothing too fancy mind you. By swapping out the song title with its winning point value that year, you have a rather simple math equation. Now let your brain do that magic PEMDAS dance.

$$\begin{aligned} &365 \times (498 - 21^2) - (29^2 + 47 \times (143 + \sqrt{49})) + 24 \times 32^2 \\ &365 \times 57 - (841 + 47 \times 150) + 24 \times 1024 \\ &20805 - 7891 + 24576 \\ &37490 \div 230 = 163 \end{aligned}$$

Oh yes that line for My Number One is also a song title. Review the Eurovision list to find out who won with 163 points. In 1999 the song Take Me to Your Heaven by Charlotte Nilsson of Sweden wins with 163 points

The answer is:  Sweden

**If you are unable to locate Clue P, open emergency envelope 13, which will direct you to Clue Q.**



**This is Clue P. Solving this clue will lead you to Clue Q.**

*This is a Visual Clue where the Hunters sees an image and four pegs to attach their provided license plate.*



**If you are unable to solve this clue, or to find Clue Q, open emergency envelope 13, which will direct you to Clue Q.**

**This is emergency solution 13, which will lead you to Clue Q.**

A clever hunter would recognize the car they see doesn't have a license plate and that they have a few plates in their brown bag! Though not necessary, the hunter may then hang the license plates on the model car. Noticing nothing happens, a wise hunter starts to make some observations... A white Ford Bronco with a license plate that says "NTGLTE" and expires in June 94. Who could that refer to but OJ Simpson?

Head to:

**OJ**

**If you are unable to locate Clue Q, open emergency envelope 8, which will direct you to Clue R.**

**This is Clue Q. Solving this clue will lead you to Clue R.**

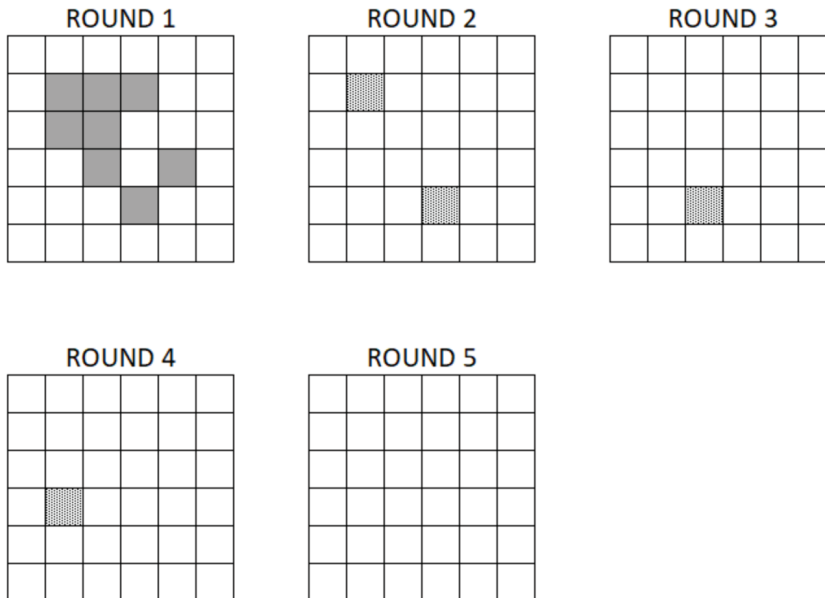

*Speckled cells are hints*

**If you are unable to solve this clue, or to find Clue R, open emergency envelope 8, which will direct you to Clue R.**

**This is emergency solution 8, which will lead you to Clue R.**

A sagacious hunter would see this clue and immediately realize this must relate to the brown bag instructions for how to play a grid-like game! But for most hunters, this probably took a minute. Following the instructions in the brown bag, a hunter begins at the starting position provided and proceeds along using the hints to guide them. When they've reached a terminal state and there are no remaining moves to make, they have found the answer!



Proceed on over to circle  for your next brain-buster!

**If you are unable to locate Clue R, open emergency envelope 23, which will direct you to Clue S.**

**This is Clue R. Solving this clue will lead you to Clue S.**

*This is a working visual clue consisting of a coffee maker with a display and keypad attached to the side.*



**If you are unable to solve this clue, or to find Clue S, open emergency envelope 23, which will direct you to Clue S.**

**This is emergency solution 23, which will lead you to Clue S.**

CAFFE1NE starved hunters will recognize C0FFEE and DECAF are hexadecimal numbers and the OR is the operation to be performed on them. Calculating:

C0FFEE OR DECAF = CDFFEF

Since the keypad only contains 0-9, hunters need to convert the hex number to decimal, which is: 13500399

Entering the correct number, the display reads, "BEEF" which is another hexadecimal word and will lead to:



**If you are unable to locate Clue S, open emergency envelope 5, which will direct you to Clue T.**



**This is Clue S. Solving this clue will lead you to Clue T.**

*Hunters arrive at their cluesite ON MARS! to catch the rover landing parachute as it is landing...*



**If you are unable to solve this clue, or to find Clue T, open emergency envelope 5, which will direct you to Clue T.**

**This is emergency solution 5, which will lead you to Clue T.**

The HWOW linked parachute should look familiar here! Thanks to Tanyafish on github, we've been taught how to decipher the Message to Mars that the folks at NASA and JPL sent on Percy's parachute.

But this earthbound parachute standing in the desert tonight has a different message. Working through the clever code, this parachute spells 'MY LANDING SITE.' So where did the original parachute originally land? The Jezero Crater!

Head over to the circle :

**JE0**

**If you are unable to locate Clue T, open emergency envelope 14, which will direct you to Clue U.**

## This is Clue T. Solving this clue will lead you to Clue U.

*This is a Working Visual Clue where Hunters encounter A Poster Board of the Disneyland Map is displayed at the site along with a legend denoting the locations. The legend is printed on the clue site scrap pages near the clue stickers. The site says: Where to Next?*



**If you are unable to solve this clue, or to find Clue U, open emergency envelope 14, which will direct you to Clue U.**

**This is emergency solution 14, which will lead you to Clue U.**

Hunters who have travelled to amusement parks of a Disney nature and enjoyed the celluloid luxuries of its parent company will no doubt recognize the titles of familiar rides and locations at the Disneyland Resort Park.

A map of Disneyland displayed at the site will remind you of the amusement park ticket in the brown bag with the words: "From A Canoe into Space." The legend provided at the site gives a list of locations at Disneyland and written in invisible ink the words: "From Indiana to Infinity and Beyond." If you draw a line from Davy Crockett's Explorer Canoes to Space Mountain and another line from Indiana Jones Adventure to Buzz Lightyear Astro Blasters, the two lines interconnect at one location. The legend provided indicates that F is where to head next at Disneyland.

The Little Red Wagon is at location F, head to Circle



**If you are unable to locate Clue U, open emergency envelope 9, which will direct you to Clue V.**

**This is Clue U. Solving this clue will lead you to Clue V.**

This message may NOT make sense:



**If you are unable to solve this clue, or to find Clue V, open emergency envelope 9, which will direct you to Clue V.**

**This is emergency solution 9, which will lead you to Clue V.**

Hunters attempting to decode the Morse code in this clue will notice the letters make no sense. The word “NOT” is the clue to solving the puzzle. The HWOW link to “Complement Arithmetic” explains how to perform 1’s complement arithmetic on binary numbers. The insightful Hunter may realize that Morse code symbols are binary in nature, and swapping dots with dashes produces valid Morse code.

Decoding the ‘flipped’ Morse code produces the phrase: “Victory goes to the player who makes the next to last mistake” [Something to ponder for the 1st and 2nd place Hunt winners...]

Anyway, this sounds like a quote by somebody. The Brown Bag page “Good Quotes and Wise Quotations” provides a large number of quotes. Locating this quote (or even just the first word ‘victory’) shows the quote was by ‘Chessmaster Savielly Grigorievitch Tartakower’.

Go to Circle **SGT**

**If you are unable to locate Clue V, open emergency envelope 24, which will direct you to Clue W.**



**This is Clue V. Solving this clue will lead you to Clue W.**

*This visual clue appears to be a standard concrete block hanging by a chain with 'How many hours?' written on the block.*



**If you are unable to solve this clue, or to find Clue W, open emergency envelope 24, which will direct you to Clue W.**

**This is emergency solution 24, which will lead you to Clue W.**

While it is not unusual for Hunters to encounter random blocks and construction materials in the desert, this seems different. Why is a block hanging from a chain? And why is it labeled "How many hours?" The crypto-astute hunter will immediately catch the reference to blockchains (the new hotness), and will recall seeing a list of top ten non-fungible tokens (which are transferred on blockchains) on the HWOW. Top on that list is an entry that involves the passage of time -- the work "Everydays - The First 5000 Days" by artist @beeples (known as Mike Winkelmann in meatspace), which sold for approximately \$69 million.

So, how many hours? It's simple:  $5000 \text{ days} * 24 \text{ hrs/day} = 120,000 \text{ hrs}$ .

So head on over to:

**120K**

**If you are unable to locate Clue W, open emergency envelope 15, which will direct you to Clue X.**

**This is Clue W. Solving this clue will lead you to Clue X.**

*This is a working visual clue where Hunters find four plastic puzzle pieces marked with letters and numbers on a table, with the following questions on the clue binder page.*

*Answer these questions then consider how the answers intersect:*

Q1: Who acted with Sean Connery in Indiana Jones and Robin and Marian?

Q2: Who acted with Sean Connery and Diana Rigg, but also sang a hit song with the other star of the Avengers, Patrick Macnee?

Q3: Who acted with Sean Connery in both Indiana Jones and Star Wars, Diana Rigg in the Avengers and Game of Thrones, and Olivia de Havilland in Anastasia?

**If you are unable to solve this clue, or to find Clue X, open emergency envelope 15, which will direct you to Clue X.**

**This is emergency solution 15, which will lead you to Clue X.**

Geometrically-inclined hunters may recall the Trilateration link on the HWOW and the page from the Brown Bag *In Memoriam* chart.

Hunters can find answers to the three questions from the table: A1: Denholm Elliot, A2: Honor Blackman, A3: Julian Glover, producing codes: A1C2E3, A2E1C3, A2D1B3. The Hunt map has rectangles containing these same codes and a black dot, but what of these puzzle pieces? Assemble the puzzle pieces in the same letter-number sequence as the codes. Place one small hole from either end of the assembled plastic pieces over the black dot within the corresponding rectangle, using the thumbtack to fix the position.

Poke the tip of a pencil or pen in the hole at the other end and draw an arc on the map, pivoting around the thumbtack. And trilateration leads us to find where the three arcs meet: at Circle "MP" for Michael Palin of Monty Python, who perhaps surprisingly, has acted with Sean Connery, Ian Holm, Robert De Nero and Jim Broadbent.

Go to **MP**

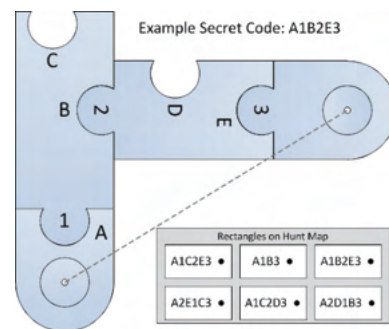

**If you are unable to locate Clue X, open emergency envelope 4, which will direct you to Clue Y.**

This is Clue X. Solving this clue will lead you to Clue Y.

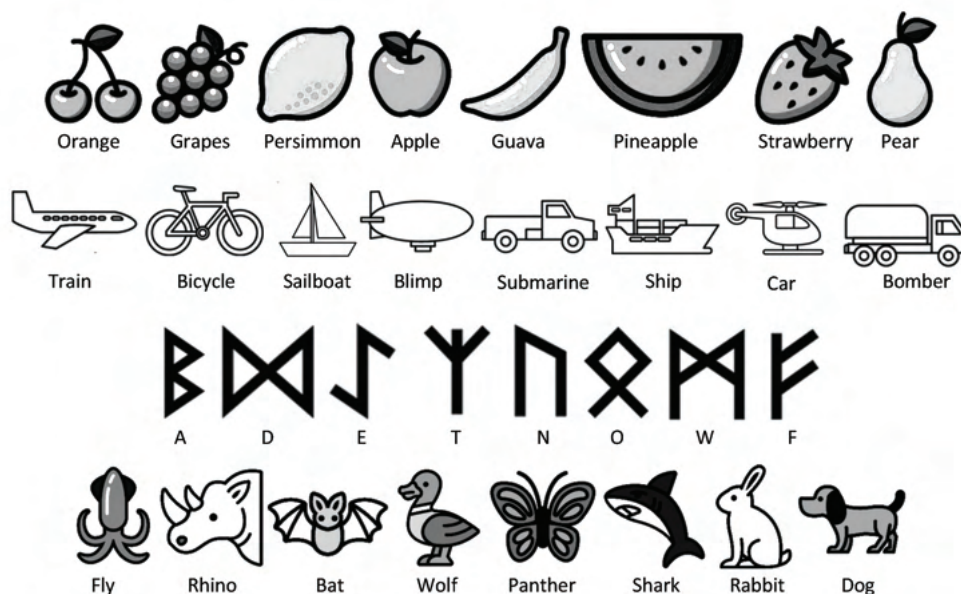

If you are unable to solve this clue, or to find Clue Y, open emergency envelope 4, which will direct you to Clue Y.

This is emergency solution 4, which will lead you to Clue Y.

“Steganography is the practice of concealing a message within another message or a physical object. In computing/electronic contexts, a computer file, message, image, or video is concealed within another file, message, image, or video.” - wikipedia

To solve this puzzle, first identify which image captions are incorrect. Each row has eight images that are true or false. Remembering the ASCII code hinted on the HOW and the Greater Futhark Rune Alphabet in the Brown Bag, each row decodes to one ASCII letter, resulting in “Steg”.

01010011 = 53<sub>16</sub>=‘s’, 01110100 = 74<sub>16</sub>=‘t’, 01100101 = 65<sub>16</sub>=‘e’, 01100111 = 67<sub>16</sub>=‘g’

Go to: 

If you are unable to locate Clue Y, open emergency envelope 20, which will direct you to Clue Z.



**This is Clue Y. Solving this clue will lead you to Clue Z.**

**Gotta catch your train! On your Marker, get set.... DRAW!**

Start at Pima and Dynamite

South 6.7 miles to the 101

West 5.7 miles to Tatum

North 3.9 miles to Jomax

East 0.4 miles to 52nd St

North 0.5 miles to Pinnacle Vista

East 0.5 miles to 56th St

North 0.5 miles to Dynamite

East 4.0 miles to Pima

**If you are unable to solve this clue, or to find Clue Z, open emergency envelope 20, which will direct you to Clue Z.**

**This is emergency solution 20, which will lead you to Clue Z.**

On your markers? Good thing you have an Official Map Marker in your brown bag! Bring that puppy out and follow the directions on your handy dandy map! By following the directions closely, this is what the clever hunter will draw:

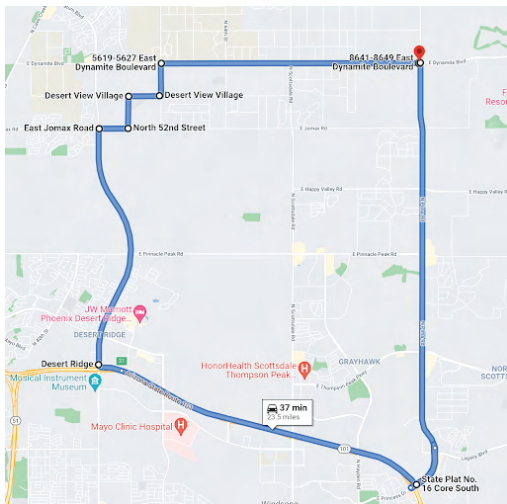

What train ride are we on anyways? The HWOW gave us some important scheduling notes by mentioning that the 3:10 to Yuma would be departing early this day--at 1:01. But there are so many different Yumas on the map! Well if we take a closer look at our new mini-AZ drawing, we will see that one of these Yumas is located in the geographically correct spot... along the 101!

Head over to:



**If you are unable to locate Clue Z, open emergency envelope 11, which will direct you to Clue A.**

**This is Clue Z. Solving this clue will lead you to Clue A.**

*This is a Visual Clue where Hunters find a post displaying a standard colorblind screening chart.*

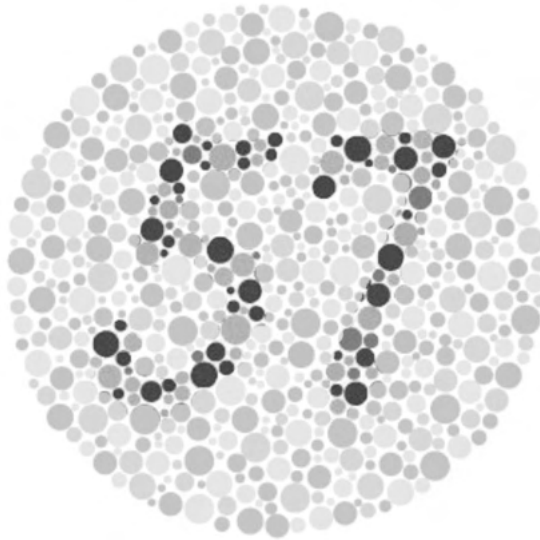

**If you are unable to solve this clue, or to find Clue A, open emergency envelope 11, which will direct you to Clue A.**

**This is emergency solution 11, which will lead you to Clue A.**

Hunters find a post displaying a standard colorblind screening chart. This particular chart shows '57' for normal sight. Some color-impaired people will see '35'. However, no humans are able to see the real answer without assistance for the chart has invisible UV paint.

Yes, it's time to whip out your UV light. You did bring one, right? Upon bathing the chart with UV, a distinct outline appears!

Go to circle:



**If you are unable to locate Clue A, open emergency envelope 6, which will direct you to Clue B.**

# TREASURE HUNT HALL OF FAME (Min/Clue)

## 1951 (27.4)

1. Frank, Estes, Lyman
2. Greer
3. Olson, Chambers, Wunderlich

## 1952 (23.8)

1. Hartman, Kemmeries, Pennington
2. Greer
3. Gundry

## 1953 (31.8)

1. Sokoloff, Diven, Drete
2. McClanathan
3. Blackert

## 1954 (23.5)

1. Chambers, Myer
2. Samuelson, Andren, Seibert
3. (no data)

## 1955 (17.6)

1. Hume, Estes, Lahti
2. Norde, Yost, Goodman
3. Ferguson, Eberhard, Drete

## 1956 (25.8)

1. Brown, Hershey, Richman
2. Samuelson, Lyman, Barton
3. Reddoch, Bettis, Martin

## 1957 (20.1)

1. Samuelson, Andrew, Barton, Weems
2. Estes, Diven, Livingwood
3. Creighton, Welch, Reeves

## 1958 (16.2)

1. Lindsay, Baum, Bettis
2. Hershey, Groth, Moore
3. Edson, Valenti, Ross, Wittenburg

## 1959 (no data)

1. Bettis, Lindsay, Martin
2. (no data)
3. (no data)

## 1960 (11.6)

1. Hinsdale, Lange, Porter
2. Kouns, Peterson, Stites
3. Corby, Peterson, Roe

## 1961 (17.9)

1. Cook, Gabrielson, Jones
2. Cooper, Cranston, Clouse
3. Yost, Goodman, Norde

## 1962 (12.2)

1. Samuelson, Welch, Kelly
2. Graham, Peterson, LaPrade
3. Groth, Knoob, Grimaila

## 1986 (20.16)

1. Carlton, Coffeen, Golis, Jacobsen, Moller, Rahrig
2. Amdahl, Williamson, Zaborowski
3. Bibby, Perkins, Stevens

## 1987 (19.38)

1. Hall, John, Presley
2. Dillon, Donaldson, Greeson, McGlinchey, Perillo
3. Clark, Gieske, O'Bannon

## 1988 (15.27)

1. Eymann, Osman, Rendek, Carleton
2. Belanger, Bjornholt, Rugen
3. Constable, Filreis, Flanigan, Hunnicutt, Prejs, Schukai

## 1989 (19.05)

1. Constable, Filreis, Flanigan, Hunnicutt, Prejs, Schukai
2. Frost, Hulet, Slick, Barry
3. Gulseth, Somers, Todd

## 1963 (16.2)

1. Michel, Barto, Solem
2. Knoob, Groth, Sanneman
3. Yost, Norde, Goodman

## 1964 (17.38)

1. Kneale, Walker, Glass
2. Knoob, Groth, Sanneman
3. Bremmer, Mayes, Lenas

## 1965 (16.0)

1. Goodman, Corby, Yost
2. Graham, Bettis, Peterson
3. Sanneman, Groth, Knoob

## 1966 (12.0)

1. Bettis, Peterson, Graham
2. Schaffner, Zusman, Voorhaar
3. Creede, Cadell, Elbinger

## 1967 (13.1)

1. Peterson, Rupprecht, Moberly
2. Ford, Wagner, Bensted
3. Porter, Lange, Attwood

## 1968 (16.6)

1. McBiles, Thomas, Hall
2. Samson, Haentze, Whittaker
3. Diven, Koch, Schwartz

## 1969 (19.8)

1. Yost, Corby, Eberhard
2. Armstrong, Woodward, Crowell
3. Sanneman, Groth, Knoob

## 1970 (17.3)

1. Greenburg, McKeown, Takesuye
2. Kline, Post, Knudsen
3. Yost, Corby, Eberhard

## 1971 (15.65)

1. Crawford, Olson, Prigge
2. Moberly, Peterson, Rupprecht
3. Haentze, Samson, Whittaker

## 1972 (19.79)

1. Clouse, Larson, Sprik
2. Bensted, Ford, Wagner
3. Bickley, McArtor, Windett

## 1973 (22.6)

1. Bickley, McArtor, Windett
2. Bliss, Chroma, Caldwell
3. Rugen, Baehr, Bjornholt

## 1974 (23.5)

1. Bliss, Chroma, Fullerton
2. Haentze, Samson, Whittaker
3. Hochgraef, Kulvinkas, Zveglic

## 1975 (24.29)

1. Henry, Tatom, Lipinski, Graham
2. Boyd, Gaines, Schaeffer
3. Fitting, Ponce de Leon, Warble

## 1976 (21.56)

1. Fajen, Kasprzyk, Kozlik
2. Samson, Whittaker, Haentze
3. Rugen, Bjornholt, Flaherty

## 1977 (18.49)

1. Bjornholt, Flaherty, Rugen
2. Andrews, Evans, Semon
3. Haentze, Samson, Whittaker

## 1978 (24.75)

1. Hall, John, Weigel
2. Armstrong, Crowell, Woodward
3. Robinson, Eslinger, Youssefi

## 1979 (20.51)

1. Oney, Furedy, Porterfield, Livingston
2. Hochgraef, Zveglic, Kulvinkas
3. Crowell, Woodward, Armstrong

## 1980 (24.65)

1. Hochgraef, Zveglic, Kulvinkas
2. Richmond, Somers, Gulseth
3. Crowell, Armstrong, Woodward

## 1981 (18.22)

1. Nalette, Defrancesco, Sewell
2. Gulseth, Somers, Richmond
3. Brenner, Wunderlich, Kaasik

## 1982 (18.13)

1. Crawford, Olson, Prigge
2. Gulseth, Richmond, Somers
3. Armstrong, Crowell, Gourley, Woodward

## 1983 (17.84)

1. Bradshaw, Cutlar, Wells
2. Anderson, Hallen, Richmond
3. Knappenberger, Nelson, Shaner

## 1984 (22.99)

1. Bliss, Chroma, Fullerton
2. Burghammer, Fah, McGlinchey
3. Eymann, Osman, Rendek

## 1985 (19.10)

1. Blair, Knott, Wibergh
2. John, Presley, Hall
3. Rugen, Bjornholt, Belanger

## 1990 (13.52)

1. Silverthorn, Fahy, Comp
2. Davis, Coon, Holm, Suppes
3. Nelson, Knappenberger, Dalton

## 1991 (17.22)

1. Albright, Black, Libby
2. Gilbert, Schaefer, Tucker, Katzdorn
3. Zaborowski, Williamson, Amdahl

## 1992 (18.83)

1. Anselme, Archambeault, Secor, Spencer, Taylor
2. Clark, Gieske, O'Bannon
3. Davis, Kirchgessner, Peterson, Sundstrom

## 1993 (17.62)

1. Frost, Hulet, Slick, Brennan
2. Davis, Peterson, Sundstrom, Leadbetter
3. Nuckolls, Waldo, Block

**1994 (25.78)**

1. Williams, Blaser, Beckwith
2. Nuckolls, Block, Waldo
3. Robb, Robb, Tolson

**1995 (17.48)**

1. Eymann, Osman, Rendek
2. Carlton, Cline, Coffeen, Jacobsen, Rahrig, Turner
3. Costa, Kirchgessner, Sutton

**1996 (18.24)**

1. Clark, Gieske, O'Bannon
2. Grube, McKay, Saewert, Stephens, Tooker
3. Robinson, Youssefi, Youssefi

**1997 (13.99)**

1. Carlton, Cline, Coffeen, Jacobsen, Rahrig, Turner
2. Cornelius, Greeson, Witwer
3. Feth, Shannon, Timmer

**1998 (18.86)**

1. Binder, Damon, Dorsett, Johnson, Smith, Sunderland
2. Carpenter, Ehorn, Pittmon, Stearns
3. Cornelius, Greeson, Witwer

**1999 (20.34)**

1. Silverthorn, Fahy, Fee
2. Zaborowski, Williamson, Amdahl
3. Filupeit, Webster, Davis, Warter, Jankovsky

**2000 (18.63)**

1. Carpenter, Stearns, Pittmon, Ehorn
2. Robb, Robb, Tolson
3. Youssefi, Robinson, McGlinchey, Youssefi

**2001 (20.41)**

1. Davis, McCaffrey, Murray, Smith, Zajac
2. Filupeit, Webster, Warter, Jankovsky, Davis
3. Perona, White, Taxier

**2002 (15.52)**

1. Robinson, Youssefi, McGlinchey, Estrada
2. Burnside, Furedy, Furedy, Furedy, Marwil, Singer
3. Cottrell, Johnson, Locker, Worcester

**2003 (15.46)**

1. Filupeit, Jankovsky, Warter, Webster
2. Feth, Olson, Shannon, Timmerman, Timmerman
3. Luke, Gieske, Karapetian, Montoya

**2004 (21.16)**

1. Luke, Gieske, Karapetian, Montoya
2. Robb, Robb, Tolson
3. Koch, Bukoski, Ellermann, Johnston, Vick, Tamis

**2005 (18.01)**

1. Youssefi, Youssefi, Carlson, Pote, Weigand, Massey
2. Saewert, Damon, Stephens, Holder, Tooker
3. Pauly, Vandivort, Clingman, Sellers, Wolnisty

**2006 (26.36)**

1. Sherman, Smith, Schmidli
2. Furedy, Singer, Woodard
3. Koch, Bukoski, Ellerman, Johnston, Park

**2007 (19.46)**

1. Klug, Berdahl, Bailey, Sandquist, McKenzie, Saunders
2. Burdeaux, Bettis, Bawcom, Rueda, Miera, Jones
3. Behrens, Behrens, Behrens, Gruber, Gruber, Blaes

**2008 (17.44)**

1. Davis, Hughes, Peterson, Lay, Lay
2. Furedy, Hansen, Furedy, Singer, Woodard, Woodard
3. Day, Hill, Varitek, Garcia, Goyer, Goyer

**2009 (26.35)**

1. Gill, Gill, Hall, Hall, Petro, Petro
2. Anderson, Anderson, DeRosa, McCready, Joost, Hoshibata
3. Youssefi, McGlinchey, Robinson, Robinson, Robinson, Deming

**2010 (17.21)**

1. Day, Goyer, Goyer, Hansen, Hull, Varitek
2. Gray, Gray, Pruitt, Pruitt, Presnell, Behm
3. Youssefi, McGlinchey, Robinson, Robinson, McHenry, Deming

**2011 (13.58)**

1. Gieske, Gieske, Webster, Webster, Warter, Warter
2. Anderson, Anderson, Derosa, McCready, Hoshilbata, Joost
3. Luke, Luke, Karapetian, Krainski, Krainski, Burgess

**2012 (17.01)**

1. Behrens, Behrens, Behrens, Behrens, Gruber, Peters
2. Todd, Douglas, Norman, Gades, Allar, Edgar
3. Dible, Dible, Longpre, Longpre, Phillips, Tripoli

**2013 (17.67)**

1. Knecht, Knecht, Naegeli, Szukala, Tompkins, Wiborg
2. Anthony, Fahy, Silverthorn
3. Coakley, Douglas, Gades, Norman, Swanson, Todd

**2014 (16.76)**

1. Dragon, Woods, Battaglia, Hart, Miera, Patno
2. Maysey, Kromholz, DiCioccio, Shaw, Strouts, Parfet
3. Evans, Evans, Evans, Semon, Perry, McElroy

**2015 (23.52)**

1. Maysey, Kromholz, DiCioccio, Shaw, Strouts, Parfet
2. Campo, Cox, Hatch, Spanne, Ellering, Robb
3. Bacon, Fabig, Fabig, Wells, Rubin-Goldberg, Noble

**2016 (17.86)**

1. Gill, Gill, Hall, Hall, Petro, Petro
2. Whipp, Whipp, Heisel, Heisel, Stephens, Stephens
3. Spellman, Spellman, Spellman, Dellow, Ivey, Wareing

**2017 (19.10)**

1. Trotter, Begg, Day, Langevin, Strickler, Woo
2. Spellman, Spellman, Spellman, Dellow, Bohl, Wareing
3. Long, Bernsee, Cianciarulo, Perrin, Sheppard, Smith

**2018 (15.93)**

1. Youssefi, Pote, Carlson, Takahashi, Woodward, Pote
2. Koch, Bukoski, Vick, Ellermann, Radobenko, Johnston
3. Logan, Logan, Werner, Werner, Parshall, Parshall

**2019 (14.01)**

1. Behrens, Behrens, Behrens, Gruber, Gruber, Blaes
2. Orlovski, Orlovski, Myers, Morrison, Morrison, Johnson
3. Rothlisberger, Rothlisberger, Rothlisberger, Rothlisberger, Neil, Neil



# **TOP 20 ALL-TIME WINNING PERFORMANCES BY AMATEUR TEAMS**

<b>Team</b>	<b>Year</b>	<b>Time/Clue</b>
1 Hinsdale, Lange, Porter	1960	11.60
2 Bettis, Peterson, Graham	1966	12.00
3 Samuelson, Welch, Kelly	1962	12.20
4 Peterson, Rupprecht, Moberly	1967	13.10
5 Silverthorn, Fahy, Comp	1990	13.52
6 Gieske (x2), Webster (x2), Warter (x2)	2011	13.58
7 Carlton, Cline, Coffee, Jacobsen, Rahrig, Turner	1997	13.99
8 Behrens (x3), Gruber (x2), Blaes	2019	14.01
9 Eymann, Osman, Rendek, Carleton	1988	15.27
10 Filupeit, Jankovsky, Warter, Webster	2003	15.46
11 Robinson, Youssefi, McGlinchey, Estrada	2002	15.52
12 Crawford, Olson, Prigge	1971	15.65
13 Youssefi, Pote (x2), Carlson, Takahashi, Woodward	2018	15.93
14 Goodman, Corby, Yost	1965	16.00
15 Lindsay, Baum, Bettis	1958	16.20
16 Michel, Barto, Solem	1963	16.20
17 McBiles, Thomas, Hall	1968	16.60
18 Dragon, Woods, Battaglia, Hart, Miera, Patno	2014	16.76
19 Binder, Damon, Dorsett, Johnson, Smith, Sunderland	1998	16.86
20 Behrens (x4), Gruber, Peters	2012	17.01

# PRO BUTTON WINNERS

Team	Year	Time/Clue
Moberly, Peterson, Rupprecht	1972	19.64
Bettis, Graham, Peterson	1973	20.82
Crawford, Olson, Prigge	1975	23.71
Bettis, Graham, Peterson	1978	22.96
Windett, McArtor, Bickley	1979	20.47
DeFrancesco, Nalette, Sewell	1987	17.28
Carlton, Coffeen, Moller, Jacobsen, Cline, Rahrig	1991	13.60
Carlton, Coffeen, Moller, Jacobsen, Cline, Rahrig	1992	15.32
Comp, Fahy, Jackson, Silverthorn	1995	13.28
Slick, Hulet, Frost	1997	13.87
Beckwith, Blessing, Stolze, Williams	1998	16.06
Silverthorn, Fahy	2003	14.46
Silverthorn, Fahy	2007	18.87
Silverthorn, Fahy	2008	15.55
Gieske (x2), Webster (x3), Warter	2009	24.36
Silverthorn (x3), Fahy (x2), Marincola	2010	14.87
Silverthorn (x3), Fahy (x2), Marincola	2016	14.19
Behrens (x3), Gruber (x2), Blaes	2017	18.31

Beginning in 1970, teams with less than three years of respite from committee service and teams with six years of committee service are offered the opportunity to declare their cars Professional. This declaration must be made upon application for tickets to the Hunt. In 1981, the 1970 resolution was amended to limit those teams wishing to declare themselves Professional to those having three or more qualifying members under the 1970 resolution.

The Treasure Hunt Committee employs the following interpretations of these resolutions:

Professional teams agree not to compete against amateur teams in the Hunt. First, second, and third place prizes will be awarded to the three amateur teams with the lowest times per clue. If a professional team has the lowest time per clue for the hunt, the team will be added to the "Pro Button Winners" section of the Hall of Fame. Those team members whose status qualified the team for professional competition will be awarded Pro Buttons to be affixed to their previously awarded red hats. Any Pro teams having times per clue better than the third place winners will be identified for their commendable performances, while those Pro teams that placed closer to the other end of the pack will also receive some "special" recognition.

Teams that are eligible to declare themselves Professional for the Hunt but do not do so, for whatever reason, will compete as amateur teams and will be eligible for the first, second and third place prizes.

# THANKS TO OUR 2021 ENTRANTS!

Team	Team Name	Status	Hunter Names
1	LumberJackAsses	Pro	Hall, Hall, Gill, Lay, Petro, Petro
2	Vax to the Future		Nalette, Nalette, Woodward, Woodward, Corely, Corely
3	Perseverabrants		Garrabrant, Garrabrant, Garrabrant, Garrabrant, Garrabrant, Silverio
4	Saved by a Jackass		Whipp, Whipp, Heisel, Heisel, Stephens, Stephens
5	The Van Goes		Burger, Burger, Burger, Mauntel, Mauntel, Garling
6	Badonkeydonks		Werner, Werner, Logan, Parshall, Holmquist, Vorce
7	Frustrated Burros of Investigation		Woolf, Woolf, Kinney, Olsen, Kinney, Stancell
8	Awesome Sauce	Pro	Kromholz, DiCioccio, Shaw, Strouts, Parfet, Weaver
9	Donkey Hôté		Spellman, Spellman, Dellow, Spellman, Ivey, Harris
10	Chicken Pot Percy		Day, Hull, Varitek, Kirkpatrick, Kolb, Ulrich
11	Six Hunters in Search of a Clue		Pelotte, Farrar, Estrin, Haskins, Munoz, Estrin
12	Tess Tickle's: Socially Distant Before it was Cool		Curry, Killion, Inouye, Halverson, Halverson, McConnell
13	X Æ A-12 Cult Followers		O'Connor, Lozevski, Lozevski, Desch, Campos, Clayton
14	Marvin The Mars Pun		Benjamin, Dore, Grandpre, Yusti, Bardwell, Bolgar
15	Absolutely Positive		Perry, Perry, Margalith, Margalith, Machado, Machado
16	My Battery is Low and it's Getting Dark		Kettner, Kettner, Pockock, Pockock, Enriquez, Olson
17	Team Astinado		Campo, Elering, Sterbenz, Rutledge, Kinsfather, Beeman
18	Rigor Tortoise		DeRosa, McCreedy, Eyres, Jacobus, Schukle, Lihs
19	Parsimonious Pandemic Opossums		Greenfield, Greenfield, Tremel, Milyard, Milyard, Vandegriff
20	Here to Establish an Alibi		Lish, Lish, Allen, Allen, Power, Power
21	Achieving Nerd Immunity		Rethemeier, Hutcheson, Shaffer, Wootten, Ashmore, Seburn
22	Rover the Hill		Klug, Klug, Guscott, Phillips, Phillips, McMahon
23	Megxit to Mars	Rookie	Forseth, Forseth, Schlarmann, Schlarmann, Puig-Ivonne, Ivonne
24	Heads of Alfredo	Pro	Gieske, Gieske, Webster, Webster, Goyer, Goyer
25	Six S's		Sherman, Sherman, Schmidli, Schmidli, Smith, Smith
26	Gamers Forever		Trakes, Berry, Smiley, Smiley, Swenson, Bell
27	United States Space Force Reserve		Woodcook, Jittu, Hayes, Jones, Vinke, Vinke
28	Socially Distancing From First Place	Pro	Dragon, Woods, Battaglia, Miera, Patno, McCaffrey
29	Jack Assingtons		Steenhoek, Steenhoek, Terlizzi, Terlizzi, Goodwin, Goodwin
30	No Signs of Intelligent life		Gray, Gray, Presnell, Gray, Verros, Scheidemandel
31	Happy Campers		Marohn, Marohn, Schaub, Schaub, Crandall, Crandall
32	nEmesis		Furedy, Furedy, Furedy, Hansen, Hansen, Zunino, TBD
33	Comet Me Bro		Spencer, Spencer, Spencer, Spencer, Barney, Spencer
34	Persever-ass Snape		Hussain, Hussain, Hussain, Ophals, Abts, Hussain
35	Sisyphus is Us		Reagan, Reagan, Thomas, Thomas, Lemm, Lemm
36	Furries Lost In The Desert	Rookie	Kasper, Kataze, Knight, Addeo, Riley, Strople
37	The Voice of Reason		Wojtulewicz, Wojtulewicz, Konitzer, Neerings, Wolf, Scheffner
38	BlueFish Group		Ellett, Ellett, Ellett, Ellett, Medina
39	Shady Saguario		Inoue, Nolte, Wells, Obrect, Drachenberg, Drachenberg
40	Where's Mary?		Coffeen, Coffeen, Garde, Rahrig, Binder, Ball
41	Let's Go sliNg Fish, man!		Fishman, Fishman, Goslin, Goslin, Ng, Ng
42	Fowler St. Clair Team 1		Locker, Clair, Fowler, Fowler, Schanaker, Best
43	Fowler St. Clair Team 2		Pedersen
44	A Few Stars Short of a Solar System		Raub, Raub, Van Dyke, Van Dyke, Bintz, Canner
45	🔥🔥🔥 (bloody burning circle)		Bragg, Egnor, Ulin, Baxter, Herrick, McCue
46	That's so Ravenclaw	Rookie	Jordan, Lo, Perez-Fox, Lazer, Lefcourt, Pfeiffer
47	48 is Great		Evans, Evans, Semon, Perry, Payne, Payne
48	Ass Hats		Carroll, Paz, Klein, Larson, Tichy, Everly
49	Team Tocino		Bacon, Wells, Wells, Rubin, Loos, TBD
50	Vanny VanVito	Rookie	Manlick, Manlick, Chiou, Mueller, Dunklee, Dunklee
51	Not Fast Also Not Furious		Hartman, Hartman, Robb, Loubikis, Waller, Waller
52	Freedom Hunters		Alexander, Alexander, Alexander, Durning, Durning
53	Spacely Space Sprockets		Boever, Potts, Provance, Provance, Farmer, Johannes
54	Burst a Beer Ants		Spencer, Spencer, Harshberger
55	The Second Place Team		Robb, Robb, Robb, Robb, Robb, Simmons
56	Team Rochette		Phillips, Mast, Chryssilla, Gieske, Jones, Joy
57	Eureka	Pro	Fahy, Silverthorn, Silverthorn, Silverthorn, Marincola, Silverthorn
58	Curiosity Killed the Jackass		Mott, Harrison, Rosso, Howe, Jaso, Nelson
59	It Really Chapz Uranus	Rookie	Chapman, Chapman, Chapman, Chapman, Chapman, Chapman
60	Space Ghost Coast to Coast		Strong, Strong, Richards, Ivery, Ivery
61	Percy's Jackastronauts		Jacobson, Jacobson, Roberts, Roberts, Binns, DeVeau
62	Clumsy Desert Aldehydes		svoboda, Svoboda, Svoboda, Svoboda, Svoboda, Svoboda
63	Shooting for Second	Rookie	Kaiser, Kaiser, Muehlhausen, Muehlhausen, Doroz, Doroz
64	2 Legit 2 Quit	Rookie	Shepherd, Magnuson, Magnuson, Hernandez, Hernandez
65	A Good Van . . . And Thorough		Robinson, McGlinchey, Robinson, Robinson, Cericola, Cericola
66	Only a Jaskass would Quit the Hunt		Grimaldi, Zaremba, Young, Stallings, Linehan, Messinger
67	The Rs on Mars		Rothlisberger, Rothlisberger, Rothlisberger, Rothlisberger, Neil, Neil
68	Jane Doe		Ehrlich, Huang, Mason, Lakhapal, Zhang, Mori
69	The Six Masketeers		Squire, Squire, Squire, Squire, Squire, McElhany
70	Fast & Furious	Rookie	Tapia, Tapia, Callahan, Tapia, Bursley, Turlip
71	Hoff's Wingmen		Snavelly, Snavelly, Thompson, Thompson, Foote, Dominguez
72	Handerson	Rookie	Hansen, Hansen, Anderson, Anderson, Anderson, Anderson
73	It's a Science Thing		Geranen, Geranen, Reynolds, Reynolds, Romero, Romero
74	Car 54		Ellermann, Johnston
75	Cereal Killers		Pettinato, Johnson, Riley, Friends, Friends, Friends
76	Behold! Jack's Ass		Millett, Eckman, Perry, Stpone, Devoe, Sanchez
77	Great Stone Asses of Mars		Collins, Low, Collins, Holbrook, Garland, Smith
78	Totally Not Lost		Behrens, Miller, Lally, Miller
79	Winners never ... ah never mind		Remington, Wilcoxen
80	Nerds+INerds		Kronick, Kronick, Kronick, Grout, Hamilton, Gardner
81	Medium Crock Pots		Kettner, Davis, Hartzburg, Hartzburg, Partiu, Ion
82	Jackasteroids		Kocur, Ovici, Amussen, Dihle, Garcia, Goth
83	Dank Poets Society		Orlowski, Orlowski, Morrison, Morrison, Myers, Johnson
84	Dragon Shepherds	Rookie	Madsen, Quiros, Quiros, Anduaga, Swatton, Richards
85	Wiley Wankers		Crabb, Wolnisty, Jardine, Vandivort, James
86	RoadRunners		Brown, Franston
87	Vaccinating the Countryside		Kurtis, Vandervort, Vandervort, Ridenour, Stafford, Stafford
88	Nemesis		Koch, Koch, Lawver, Lawver, Bump, Bump
89	Quick, Think of a Name		Carlson, Vahidi, Vahidi, Ramirez, Fisher, Kuznia
90	Arizona Carolina's		Sessions, Mannes, Cassaday, Cassaday, Day, Day

# YOUR 2020/2021 COMMITTEE:



Jason Trotter  
Carl Day  
**Sages**

B+

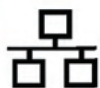

+GE+



-YL

Richard Begg  
Richard Langevin  
**Logistics**



-DS

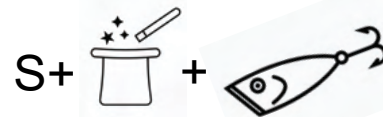

Mable Woo  
Eric Strickler  
**Finances**

P+



-S



+



-L+A+



+I



+L+



P+



-S

Andy Woodward  
Carter Pote  
**Supplies**



+F+E

Mark Takahashi  
David Youssefi  
**Publicity**



+N+N



+N+N

Nikki Behrens  
Bob Behrens  
**Brown Bag & HWOW**



+



Nina Gruber  
Eric Gruber  
**Cluebook**